



APPLICATION FOR ELECTROMAGNETIC COMPATIBILITY DIRECTIVE

On Behalf of

Mid Ocean Brands B.V.

Warning Torch

Model No.: MO9326

Prepared for : Mid Ocean Brands B.V.

Address : Unit 201, 2/F., Laford Centre, 838 Lai Chi Kok Road,
Cheung Sha Wan, Kowloon, Hong Kong.

Prepared By : Shenzhen Alpha Product Testing Co., Ltd.

Address : Building i, No.2, Lixin Road, Fuyong Street, Bao'an District,
518103, Shenzhen, Guangdong, China

Report Number : T1871539 01
Date of Receipt : August 24, 2017
Date of Test : August 24, 2017
Date of Report : September 29, 2017
Version Number : REV0

TABLE OF CONTENTS

Description	Page
1. Summary Of Standards And Results	6
1.1. Description of Standards and Results	6
2. General Information	7
2.1. Description of Device (EUT).....	7
2.2. Tested Supporting System Details	8
2.3. Block Diagram of connection between EUT and simulators.....	8
2.4. Test Mode Description.....	9
2.5. Test Facility	10
2.6. Measurement Uncertainty	10
3. Conducted Disturbance At Mains Terminals Test.....	11
3.1. Test Equipment	11
3.2. Block Diagram of Test Setup.....	11
3.3. Test Standard	11
3.4. Power Line Conducted Emission Test Limits	11
3.5. Configuration of EUT on Test	12
3.6. Operating Condition of EUT	12
3.7. Test Procedure	12
3.8. Conducted Disturbance at Mains Terminals Test Results	13
4. Radiated Electromagnetic Disturbance Test	14
4.1. Test Equipment	14
4.2. Block Diagram of Test Setup.....	14
4.3. Test Standard	14
4.4. Radiated Electromagnetic Disturbance Limits	14
4.5. EUT Configuration on Test	14
4.6. Operating Condition of EUT	15
4.7. Test Procedure	15
4.8. Radiated Electromagnetic Disturbance Test Results	16
5. Radiated Disturbance Test	20
5.1. Test Equipment	20
5.2. Block Diagram of Test Setup.....	20
5.3. Test Standard	20
5.4. Radiated Disturbance Limit	20
5.5. Configuration of EUT on Test	21
5.6. Operating Condition of EUT	21
5.7. Test Procedure	21
5.8. Radiated Disturbance Test Result	22
6. Harmonic Current Test	25
6.1. Test Equipment	25
6.2. Block Diagram of Test Setup.....	25
6.3. Test Standard	25

6.4.	Harmonic Current Test Limits	25
6.5.	Configuration of EUT on Test	26
6.6.	Operating Condition of EUT	26
6.7.	Test Procedure	26
6.8.	Harmonic Current Test Results.....	27
7.	Voltage Fluctuations & Flicker Test.....	28
7.1.	Test Equipment	28
7.2.	Block Diagram of Test Setup.....	28
7.3.	Test Standard	28
7.4.	Voltage Fluctuation and Flicker Test Limits	28
7.5.	Configuration of EUT on Test	29
7.6.	Operating Condition of EUT	29
7.7.	Test Procedure	29
7.8.	Voltage Fluctuation and Flicker Test Results.....	30
8.	IMMUNITY PERFORMANCE CRITERIA.....	31
9.	Electrostatic Discharge Test	32
9.1.	Test Equipment	32
9.2.	Block Diagram of Test Setup.....	32
9.3.	Test Standard	32
9.4.	Electrostatic Discharge Test Limits	32
9.5.	Configuration of EUT on Test	32
9.6.	Operating Condition of EUT	33
9.7.	Test Procedure	33
9.8.	Electrostatic Discharge Test Results.....	34
10.	RF Field Strength Susceptibility Test.....	35
10.1.	Test Equipment	35
10.2.	Block Diagram of Test Setup.....	35
10.3.	Test Standard	35
10.4.	RF Field Strength susceptibility Test Limits	36
10.5.	Configuration of EUT on Test	36
10.6.	Operating Condition of EUT	36
10.7.	Test Procedure	36
10.8.	RF Field Strength Susceptibility Test Results	37
11.	Electrical Fast Transient/Burst immunity Test	38
11.1.	Test Equipment	38
11.2.	Block Diagram of Test Setup.....	38
11.3.	Test Standard	38
11.4.	Electrical Fast Transient/Burst Test Limits	39
11.5.	Configuration of EUT on Test	39
11.6.	Operating Condition of EUT	39
11.7.	Test Procedure	39
11.8.	Electrical Fast Transient/Burst immunity Test Results	40
12.	SURGE Test.....	41
12.1.	Test Equipments.....	41
12.2.	Block Diagram of Test Setup.....	41

12.3. Surge Test Limits	41
12.4. Configuration of EUT on Test	42
12.5. Operating Condition of EUT	42
12.6. Test Procedure	42
12.7. Surge Test Results.....	43
13. Injected currents susceptibility test	44
13.1. Test Equipments.....	44
13.2. Block Diagram of Test Setup.....	44
13.3. Test Standard	44
13.4. Injected currents susceptibility Test Limits	45
13.5. Configuration of EUT on Test	45
13.6. Operating Condition of EUT	45
13.7. Test Procedure	45
13.8. Injected currents susceptibility Test Results.....	46
14. magnetic field immunity test	47
14.1. Test Equipments.....	47
14.2. Block Diagram of Test Setup.....	47
14.3. Test Standard	47
14.4. magnetic field Test Limits	48
14.5. Configuration of EUT on Test	48
14.6. Operating Condition of EUT	48
14.7. Test Procedure	48
14.8. magnetic field immunity Test Results	49
15. Voltage dips and interruptions test.....	50
15.1. Test Equipments.....	50
15.2. Block Diagram of Test Setup.....	50
15.3. Test Standard	50
15.4. Voltage dips and interruptions Test Limits.....	51
15.5. Configuration of EUT on Test	51
15.6. Operating Condition of EUT	51
15.7. Test Procedure	51
15.8. Voltage dips and interruptions Test Results	52
16. Photograph.....	53
16.1. Photos of Radiated Disturbance Test (In Semi Anechoic Chamber).....	53
16.2. Photos of Radiated Electromagnetic Disturbance Test.....	53
16.3. Photos of Electrostatic Discharge Test	54
16.4. Photos of RF Field Strength Susceptibility Test.....	54
17. Photos Of The EUT	55

TEST REPORT DECLARATION

Applicant : Mid Ocean Brands B.V.
 Manufacturer : /
 EUT Description : Warning Torch
 (A) Model No. : MO9326
 (B) Ratings Supply : DC 4.5V from battery
 (C) Test Voltage : DC 4.5V from battery

Measurement Standard Used:

EN 55015:2013

EN 61547:2009

The device described above is tested by Shenzhen Alpha Product Testing Co., Ltd. to determine the maximum emission levels emanating from the device and the severe levels of the device can endure and its performance criterion. The test results are contained in this test report and Shenzhen Alpha Product Testing Co., Ltd. is assumed full responsibility for the accuracy and completeness of test. Also, this report shows that the EUT is technically compliant with the EN 55015 and EN 61547 requirements.

This report applies to above tested sample only. This report shall not be reproduced in parts without written approval of Shenzhen Alpha Product Testing Co., Ltd.

Tested by (name + signature).....: Star Yang
 Project Engineer

Approved by (name + signature).....: Simple Guan
 Project Manager

Date of issue..... : September 29, 2017



1. SUMMARY OF STANDARDS AND RESULTS

1.1. Description of Standards and Results

The EUT have been tested according to the applicable standards as referenced below:

EMISSION				
Description of Test Item	Standard	Limits		Results
Disturbance Voltages at mains terminals	EN 55015:2013	Section 4.3		N/A
Radiated Electromagnetic Disturbance	EN 55015:2013	Section 4.4.1		P
Radiated Disturbance	EN 55015:2013	Section 4.4.2		P
Harmonic current emissions	EN 61000-3-2:2014	Class C		N/A
Voltage fluctuations & flicker	EN 61000-3-3:2013	Section 5		N/A
IMMUNITY (EN 61547:2009)				
Description of Test Item	Standard	Performance Criteria	Observation Criteria	Results
Electrostatic discharge (ESD)	IEC 61000-4-2:2008	B	A	P
Radio-frequency, Continuous radiated disturbance	IEC 61000-4-3:2006+A1:2007+A2:2010	A	A	P
Electrical fast transient (EFT)	IEC 61000-4-4:2012	B	N/A	N/A
Surge	IEC 61000-4-5:2014	C	N/A	N/A
Radio-frequency, Continuous conducted disturbance	IEC 61000-4-6:2013	A	N/A	N/A
Power frequency magnetic field	IEC 61000-4-8:2009	A	N/A	N/A
Voltage dips, 100% reduction	IEC 61000-4-11:2004	B	N/A	N/A
Voltage dips, 30% reduction		C	N/A	N/A
Note: 1. P is an abbreviation for Pass. 2. F is an abbreviation for Fail. 3. N/A is an abbreviation for Not Applicable.				

2. GENERAL INFORMATION

2.1. Description of Device (EUT)

Description : Warning Torch

Model Number : MO9326

Test Voltage : DC 4.5V from battery

Classification : Class III

Applicant : Mid Ocean Brands B.V.

Address : Unit 201, 2/F., Laford Centre, 838 Lai Chi Kok Road,
Cheung Sha Wan, Kowloon, Hong Kong.

Manufacturer : /

Address : /

Sample Type : Prototype production

2.2. Tested Supporting System Details

No.	Description	Manufacturer	Model	Serial Number
1	N/A	N/A	N/A	N/A

2.3. Block Diagram of connection between EUT and simulators

For EMI and EMS Tests



EUT: Warning Torch

2.4. Test Mode Description

For Radiated & EM Test		
No.	Test Mode	Test Voltage
1.	Steady ON	DC 4.5V from battery
2	flash Max	DC 4.5V from battery
	flash Min	DC 4.5V from battery

Note: Steady ON is the worst mode for all test, this report only reflected Steady ON mode

2.5. Test Facility

Shenzhen Alpha Product Testing Co., Ltd.

Building i, No.2, Lixin Road, Fuyong Street, Bao'an District, 518103, Shenzhen, Guangdong, China

2.6. Measurement Uncertainty

(95% confidence levels, k=2)

Test Item	Uncertainty	U_{cispr}
Uncertainty for Conduction emission test	2.74dB	3.8 dB
Uncertainty for Radiation Emission test	3.77 dB (Distance: 3m Polarize: V)	5.2 dB
	3.80 dB (Distance: 3m Polarize: H)	
Uncertainty for Radiation Emission test (1GHz-18GHz)	4.13 dB (Distance: 3m Polarize: V)	5.2 dB
	4.16 dB (Distance: 3m Polarize: H)	
Radiated Electromagnetic Disturbance test	1.96	/

3. CONDUCTED DISTURBANCE AT MAINS TERMINALS TEST

3.1. Test Equipment

Item	Equipment	Manufacturer	Model No.	Serial No.	Last Cal.	Cal. Interval
1.	Test Receiver	Rohde & Schwarz	ESCI	101165	2016.09.29	1 Year
2.	L.I.S.N.#1	Schwarzbeck	NSLK8126	8126466	2016.09.29	1 Year
3.	L.I.S.N.#2	ROHDE&SCHWARZ	ENV216	101043	2016.09.29	1 Year
4.	Pulse Limiter	Schwarzbeck	9516F	9618	2016.09.29	1 Year

3.2. Block Diagram of Test Setup

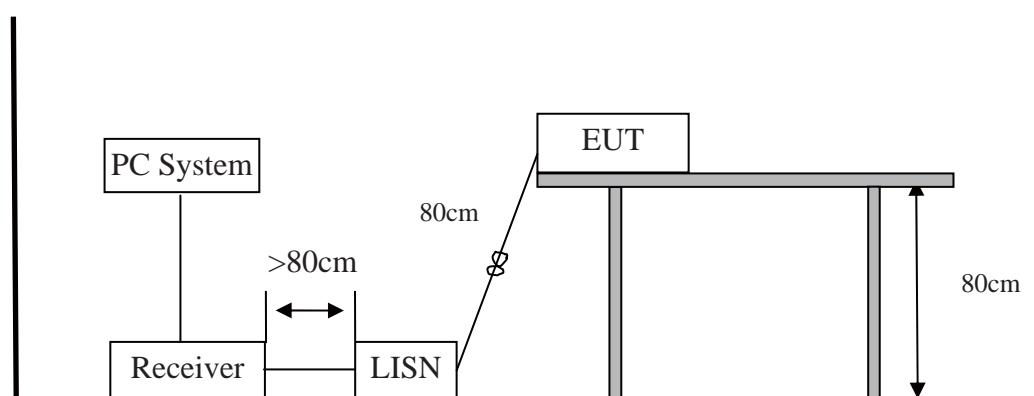

3.3. Test Standard

EN 55015:2013

3.4. Power Line Conducted Emission Test Limits

Frequency	Maximum RF Line Voltage	
	Quasi-Peak Level dB(μ V)	Average Level dB(μ V)
9kHz ~ 50kHz	110	--
50kHz ~ 150kHz	90 ~ 80*	--
150kHz ~ 0.5MHz	66 ~ 56*	56 ~ 46*
0.5MHz ~ 5.0MHz	56	46
5.0MHz ~ 30MHz	60	50

- Notes:
1. Emission level=Read level + LISN factor-Preamp factor + Cable loss
 2. * Decreasing linearly with logarithm of frequency.
 3. The lower limit shall apply at the transition frequencies.

3.5. Configuration of EUT on Test

The following equipment are installed on conducted disturbance at mains terminals to meet the EN 55015 requirement and operating regulations in a manner which tends to maximize its emission characteristics in a normal application.

3.6. Operating Condition of EUT

- (1) Setup the EUT as shown as Section 3.2.
- (2) Turn on the power of all equipment.
- (3) Let the EUT work in test mode and 15 minutes before taking the test.

3.7. Test Procedure

- (1) The EUT was placed on a non-metallic table, 80cm above the ground plane. The EUT Power connected to the power mains through a line impedance stabilization network (L.I.S.N. #1). The power line was checked for maximum conducted interference. In order to find the maximum emission, the relative positions of equipments and all of the interface cables were changed according to EN 55015 on Conducted Disturbance at Mains Terminals test.
- (2) The bandwidth of test receiver (R & S ESCI) is set: 200Hz at 9kHz to 150kHz, 9kHz at 150kHz to 30MHz.
- (3) The frequency range from 9kHz to 30MHz is checked. The test result are reported on Section 3.8.

3.8. Conducted Disturbance at Mains Terminals Test Results

EUT : Warning Torch	Test Date : N/A
M/N : MO9326	Temperature : N/A
Test Engineer : N/A	Humidity : N/A
Test Voltage : N/A	Pressure : N/A
Test Mode : N/A	
Test Results : N/A	
Note : The EUT is supplied by battery, so this item does not applicable	

4. Radiated Electromagnetic Disturbance Test

4.1. Test Equipment

For frequency range 30MHz~1GHz (At Semi Anechoic Chamber)						
Item	Equipment	Manufacturer	Model No.	Serial No.	Last Cal	Cal. Interval
1.	Test Receiver	Rohde & Schwarz	ESCI	101165	2016.09.29	1 Year
2.	Triple-loop Antenna	EVERFINE	LLA-2	11050002	2016.09.30	2 Year

4.2. Block Diagram of Test Setup

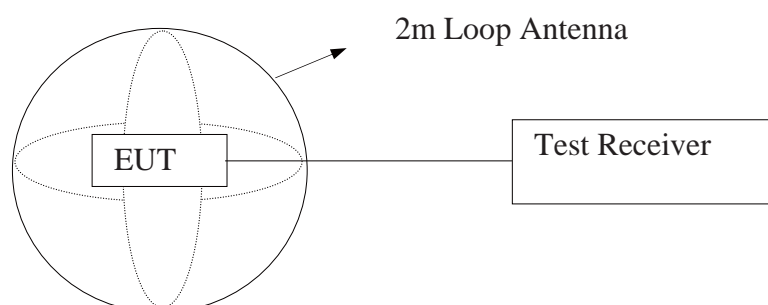

(EUT: Warning Torch)

4.3. Test Standard

EN 55015:2013

4.4. Radiated Electromagnetic Disturbance Limits

Frequency	Limits for loop diameter (dB μ A)
	2m
9kHz ~ 70kHz	88
70kHz ~ 150kHz	88 ~ 58*
150kHz ~ 3.0MHz	58 ~ 22*
3.0MHz ~ 30MHz	22

Notes: 1. * Decreasing linearly with logarithm of frequency.

2. The lower limit shall apply at the transition frequencies.

4.5. EUT Configuration on Test

The following equipments are installed on Radiated Electromagnetic Disturbance Test to meet EN 55015 requirement and operating in a manner that tends to maximize its emission characteristics in a normal application.

4.6. Operating Condition of EUT

- (1) Setup the EUT and simulator as shown as Section 4.2.
- (2) Turned on the power of all equipment.
- (3) Let the EUT worked in test mode and 15 minutes after taking the test.

4.7. Test Procedure

The EUT was placed on a wood table in the center of a loop antenna. The induced current in the loop antenna is measured by means of a current probe and the test receiver. A three-field component was checked by means of a coaxial switch.

The frequency range from 9kHz to 30MHz was checked. The receiver was measured with the quasi-peak detector. For frequency band 9kHz to 150kHz.

The bandwidth of the field strength meter (R&S test receiver ESCI) is set at 200Hz.

For frequency band 150kHz to 30MHz, the bandwidth is set at 9kHz. The test result are reported on Section 4.8.

4.8.Radiated Electromagnetic Disturbance Test Results

EUT : Warning Torch	Test Date : 2017. 08. 24
M/N : MO9326	Temperature : 24°C
Test Engineer : Star Yang	Humidity : 45%
Test Voltage : DC 4.5V from battery	Pressure : 101.3Kpa
Test Mode : ON	
Test Results : PASS	
Note: 1. The test results are listed in next pages. 2. If the limits for the measurement with the quasi-peak detector are met when using a receiver with a peak detector, the test unit shall be deemed to meet both limits and the measurement with the quasi-peak detector need not be carried out.	

Antenna Polarity: X

Conducted Emission Measurement

File : MO9326

Data :#1

Date: 2017-08-24

Time: 13:43:05

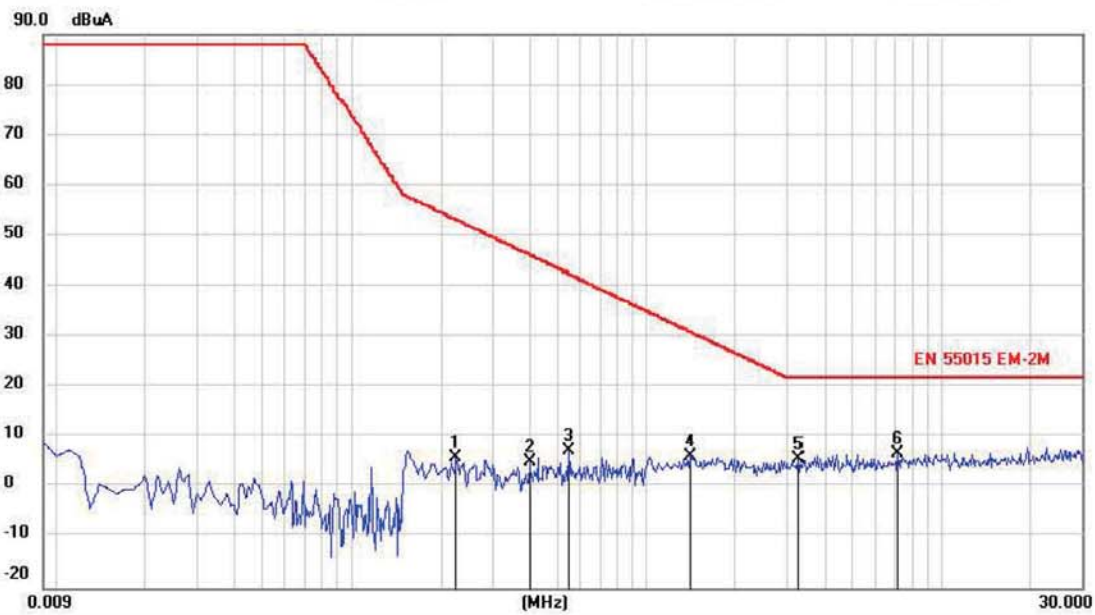

No.	Mk.	Freq. MHz	Reading Level dBuA	Correct Factor dB	Measure- ment dBuA	Limit dBuA	Margin dB	Detector	Comment
1		0.2265	6.01	0.08	6.09	53.05	-46.96	peak	
2		0.4020	5.18	0.08	5.26	46.15	-40.89	peak	
3		0.5459	7.16	0.08	7.24	42.48	-35.24	peak	
4		1.4204	6.10	0.10	6.20	30.98	-24.78	peak	
5		3.3003	5.53	0.13	5.66	22.00	-16.34	peak	
6	*	7.0804	6.64	0.19	6.83	22.00	-15.17	peak	

*:Maximum data x:Over limit l:over margin

Note: Measurement=Reading Level+Correc Factor, Factor=(LISN or ISN or PLC or Current Probe)Factor+Cable

Antenna Polarity: Y

Conducted Emission Measurement

File : MO9326

Data :#2

Date: 2017-08-24

Time: 13:46:19

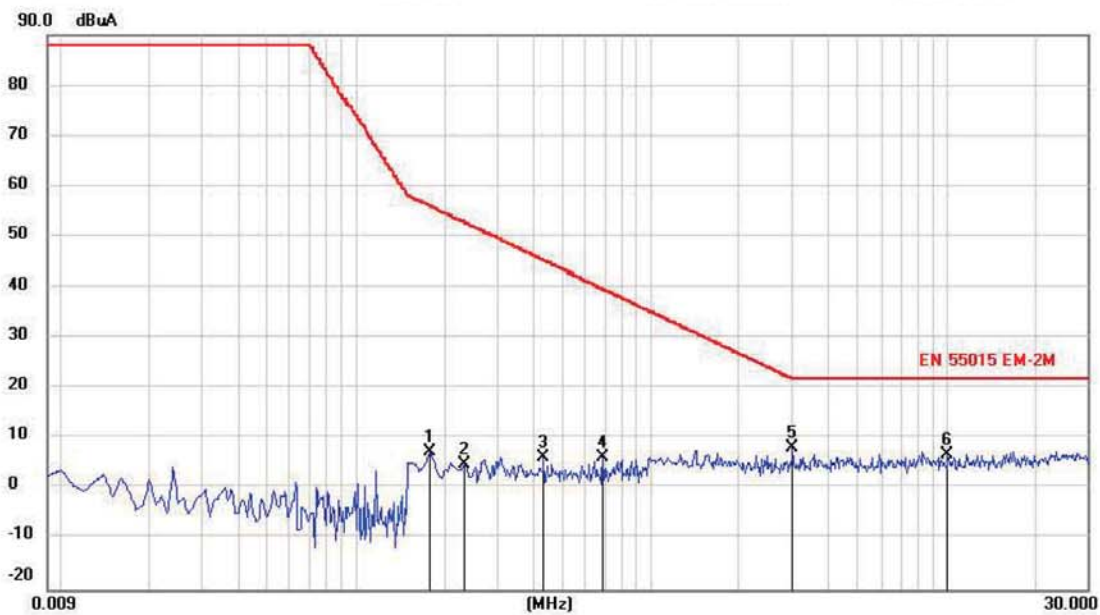

No.	Mk.	Freq. MHz	Reading Level dBuA	Correct Factor dB	Measure- ment dBuA	Limit dBuA	Margin dB	Detector	Comment
1		0.1768	7.27	0.08	7.35	56.02	-48.67	peak	
2		0.2310	4.93	0.08	5.01	52.81	-47.80	peak	
3		0.4334	6.14	0.08	6.22	45.25	-39.03	peak	
4		0.6854	6.14	0.08	6.22	39.74	-33.52	peak	
5	*	3.0402	7.96	0.13	8.09	22.00	-13.91	peak	
6		10.0602	6.76	0.18	6.94	22.00	-15.06	peak	

*:Maximum data x:Over limit !:over margin

Note: Measurement=Reading Level+Correc Factor. Factor=(LISN or ISN or PLC or Current Probe)Factor+Cable

Antenna Polarity: Z

Conducted Emission Measurement

File : MO9326

Data :#3

Date: 2017-08-24

Time: 13:50:46

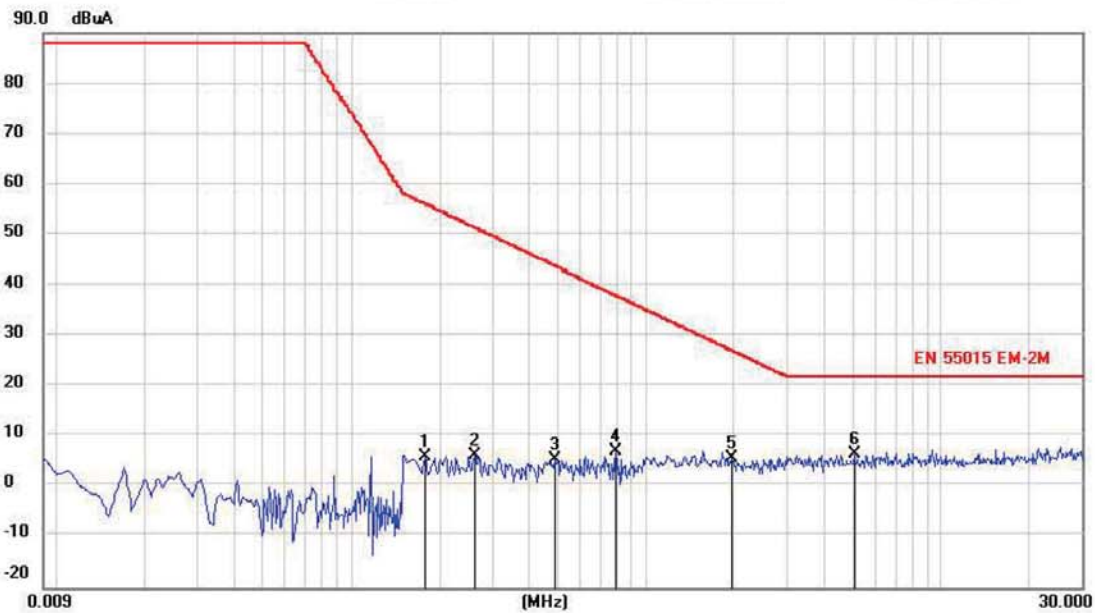

No.	Mk.	Freq. MHz	Reading Level dBuA	Correct Factor dB	Measure- ment dBuA	Limit dBuA	Margin dB	Detector	Comment
1		0.1768	5.92	0.08	6.00	56.02	-50.02	peak	
2		0.2625	6.26	0.08	6.34	51.28	-44.94	peak	
3		0.4873	5.47	0.08	5.55	43.84	-38.29	peak	
4		0.7889	6.95	0.10	7.05	38.05	-31.00	peak	
5		1.9602	5.68	0.10	5.78	27.11	-21.33	peak	
6	*	5.0403	6.28	0.16	6.44	22.00	-15.56	peak	

*:Maximum data x:Over limit !:over margin

Note: Measurement=Reading Level+Correc Factor, Factor=(LISN or ISN or PLC or Current Probe)Factor+Cable

5. RADIATED DISTURBANCE TEST

5.1. Test Equipment

For frequency range 30MHz~1GHz (At Semi Anechoic Chamber)						
Item	Equipment	Manufacturer	Model No.	Serial No.	Last Cal.	Cal. Interval
1	Test Receiver	Rohde&Schwarz	ESR	1316.3003K0 3-102082-Wa	2016.09.29	1 Year
2	Bilog Antenna	Schwarzbeck	VULB 9168	9168-438	2016.09.30	2 Year

5.2. Block Diagram of Test Setup

In Semi Anechoic Chamber (3m) Test Setup Diagram for 30MHz~1000MHz

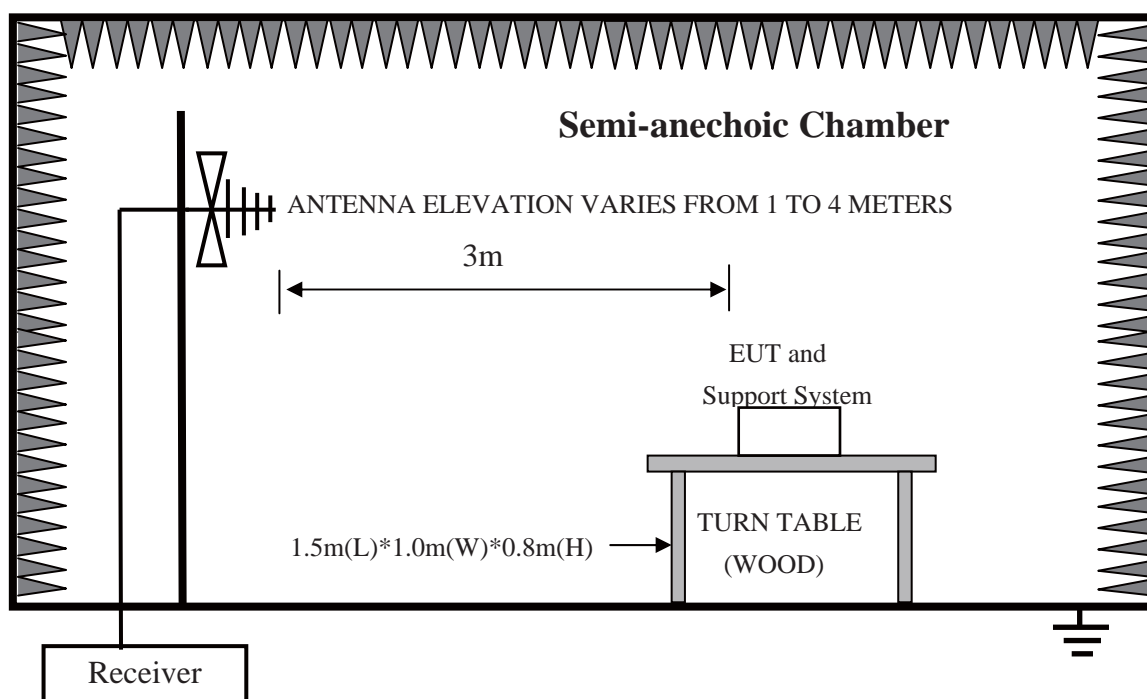

5.3. Test Standard

EN 55015:2013

5.4. Radiated Disturbance Limit

All emanations from computing devices or system, including any network of conductors and apparatus connected thereto, shall not exceed the level of field strengths specified below:

FREQUENCY (MHz)	DISTANCE (Meters)	FIELD STRENGTHS LIMITS (dB μ V/m)
30 ~ 230	3	40
230 ~ 300	3	47

- Note: (1) Emission level = Read level + Antenna Factor-Preamplifier Factor +Cable Loss
(2) The lower limit shall apply at the transition frequencies.
(3) Distance refers to the distance in meters between the test antenna and the closed point of any part of the EUT.

5.5.Configuration of EUT on Test

The following equipment are installed on Radiated Emission Test to meet the EN 55015 requirements and operating regulations in a manner that tends to maximize its emission characteristics in normal application.

5.6.Operating Condition of EUT

- (1) Setup the EUT as shown as Section 5.2.
- (2) Turn on the power of all equipment.
- (3) Let the EUT work in test mode and 15 minutes before taking the test.

5.7.Test Procedure

The EUT was placed on a non-metallic table, 80 cm above the ground plane inside a semi-anechoic chamber. An antenna was located 3m from the EUT on an adjustable mast. A pre-scan was first performed in order to find prominent radiated emissions. For final emissions measurements at each frequency of interest, the EUT were rotated and the antenna height was varied between 1m and 4m in order to maximize the emission. Measurements in both horizontal and vertical polarities were made and the data was recorded. In order to find the maximum emission, the relative positions of equipments and all of the interface cables were changed according to EN 55015 on Radiated Disturbance test.

The bandwidth setting on the test receiver (R&S TEST RECEIVER ESR) is 120 kHz. The frequency range from 30MHz to 300MHz is checked. Test results are reported in Section 5.8.

5.8.Radiated Disturbance Test Result

For below 1G radiated disturbance test result:	
EUT : Warning Torch	Test Date : 2017. 08. 24
M/N : MO9326	Temperature : 23.8°C
Test Engineer : Star Yang	Humidity : 56%
Test Voltage : DC 4.5V from battery	Pressure : 101.3Kpa
Test Mode : ON	
Test Results : PASS	
Note: 1. The test results are listed in next pages. 2. If the limits for the measurement with the quasi-peak detector are met when using a receiver with a peak detector, the test unit shall be deemed to meet both limits and the measurement with the quasi-peak detector need not be carried out.	

Antenna Polarity: V

Radiated Emission Measurement

File :2017

Data :#8

Date: 2017/8/24

Time: 15:27:28

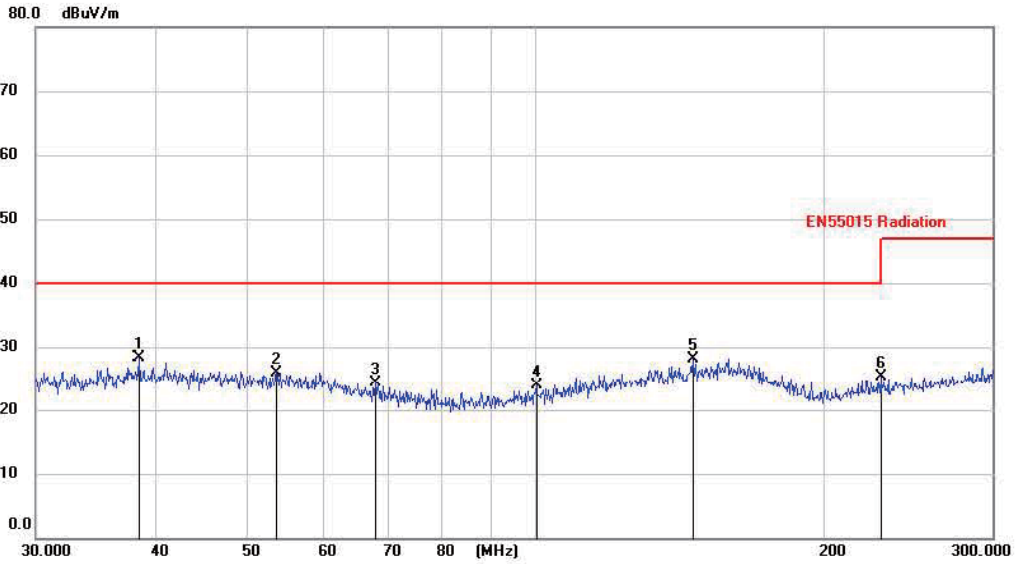

No.	Mk.	Freq.	Reading Level	Correct Factor	Measurement	Limit	Margin	Antenna Height	Table Degree	
		MHz	dBuV	dB	dBuV/m	dBuV/m	dB	cm	degree	Comment
1	*	38.3814	14.32	13.96	28.28	40.00	-11.72			peak
2		53.4714	12.56	13.44	26.00	40.00	-14.00			peak
3		67.9393	12.85	11.50	24.35	40.00	-15.65			peak
4		100.2585	13.33	10.64	23.97	40.00	-16.03			peak
5		145.9222	13.95	14.25	28.20	40.00	-11.80			peak
6		229.6790	13.57	11.77	25.34	40.00	-14.66			peak

Note: 1. *:Maximum data; x:Over limit; l:over margin.

2.Measurement=Reading Level+Correct Factor; Correct Factor=Antenna Factor+Cable Loss.

Antenna Polarity: H

Radiated Emission Measurement

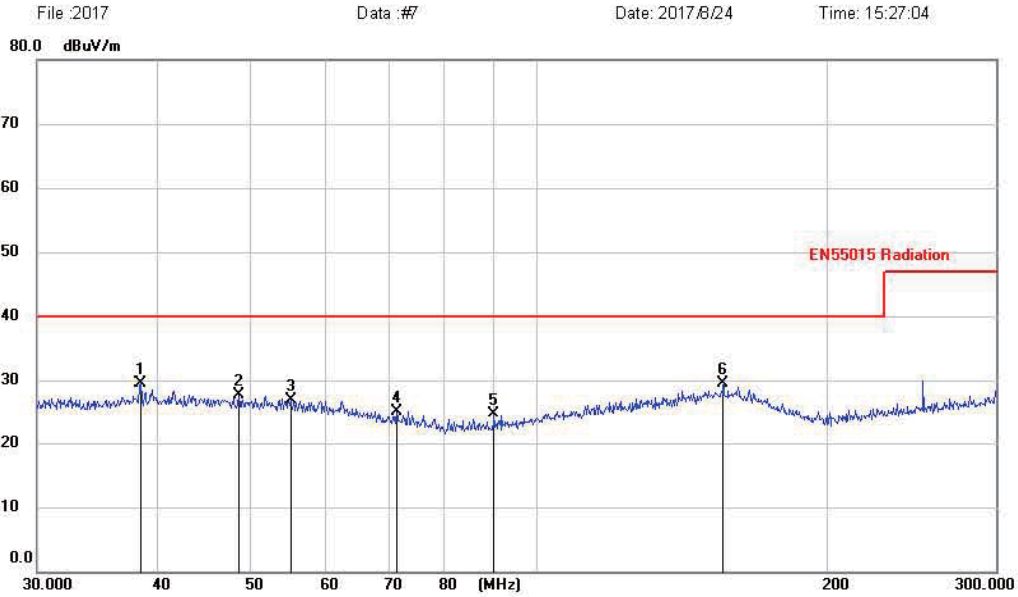

No.	Mk.	Freq. MHz	Reading Level dBuV	Correct Factor dB	Measure- ment dBuV/m	Limit dBuV/m	Margin dB	Antenna Height cm	Table Degree	Comment
1	*	38.3814	15.60	13.96	29.56	40.00	-10.44			peak
2		48.6543	14.02	13.66	27.68	40.00	-12.32			peak
3		55.2232	13.65	13.25	26.90	40.00	-13.10			peak
4		71.1412	14.42	10.68	25.10	40.00	-14.90			peak
5		90.1822	14.86	9.81	24.67	40.00	-15.33			peak
6		155.9987	14.98	14.57	29.55	40.00	-10.45			peak

Note: 1. *:Maximum data; x:Over limit; l: over margin.

2. Measurement=Reading Level+Correct Factor; Correct Factor=Antenna Factor+Cable Loss.

6. HARMONIC CURRENT TEST

6.1. Test Equipment

Item	Equipment	Manufacturer	Model No.	Serial No.	Last Cal.	Cal. Interval
1	Harmonics Flicker Analyser	Voltech	PM6000	20000670049 5	2016.09.29	1 Year

6.2. Block Diagram of Test Setup

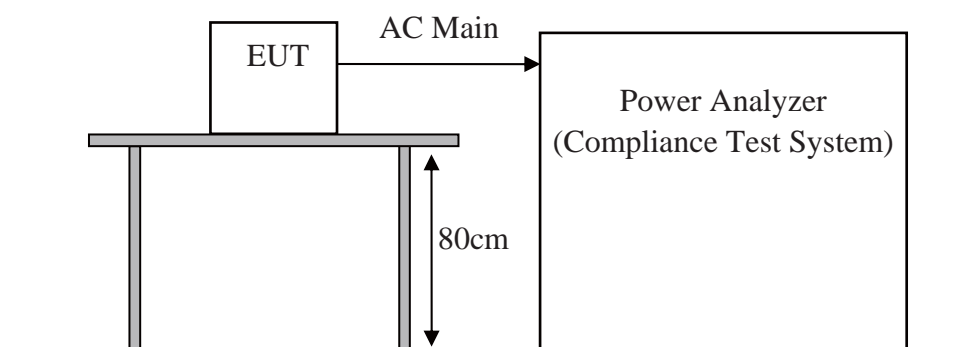

6.3. Test Standard

EN 61000-3-2: 2014, Class C

6.4. Harmonic Current Test Limits

Limits for Class C equipment	
Harmonic order	Maximum permissible harmonic current expressed as a percentage of the input current at the fundamental frequency
n	%
2	2
3	30 · λ *
5	
7	10
9	7
11 ≤ n ≤ 39 (odd harmonics only)	5
	3

* λ is the circuit power factor

6.5. Configuration of EUT on Test

The following equipment are installed on Harmonic Current Test to meet the EN61000-3-2 requirements and operating regulations in a manner that tends to maximize its emission characteristics in normal application.

6.6. Operating Condition of EUT

- (1) Setup the EUT as shown as Section 6.2.
- (2) Turn on the power of all equipment.
- (3) Let the EUT work in test mode and 15 minutes before taking the test.

6.7. Test Procedure

- (1) The EUT was placed on the top of a wooden table 0.8 meters above the ground and operated to produce the maximum harmonic components under normal operating conditions for each successive harmonic component in turn. The correspondent test program of test instrument to measure the current harmonics emanated from EUT is chosen. The measure time shall be not less than the necessary for the EUT to be exercised.
- (2) The test results are reported on Section 6.8.

6.8. Harmonic Current Test Results

EUT : Warning Torch	Test Date : N/A
M/N : MO9326	Temperature : N/A
Test Engineer : N/A	Humidity : N/A
Test Voltage : N/A	Pressure : N/A
Test Mode : N/A	
Test Results : N/A	
Note: The EUT is supplied by battery, so this item does not applicable	

7. VOLTAGE FLUCTUATIONS & FLICKER TEST

7.1. Test Equipment

Item	Equipment	Manufacturer	Model No.	Serial No.	Last Cal.	Cal. Interval
1	Harmonics Flicker Analyser	Voltech	PM6000	20000670049 5	2016.09.29	1 Year

7.2. Block Diagram of Test Setup

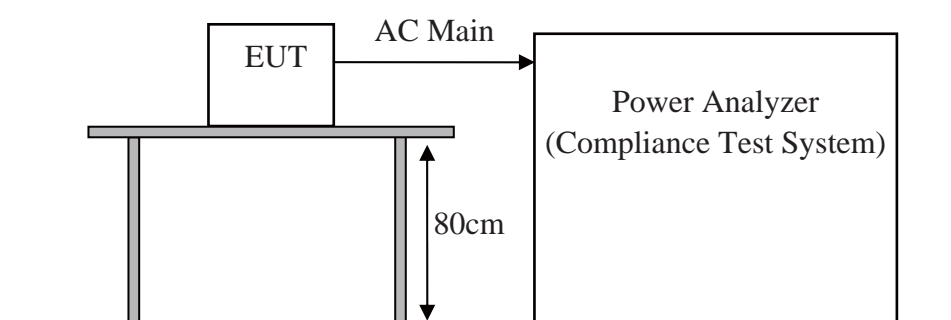

7.3. Test Standard

EN 61000-3-3: 2013

7.4. Voltage Fluctuation and Flicker Test Limits

Test Item	Limit	Note
P_{st}	1.0	P_{st} means Short-term flicker indicator
P_{lt}	0.65	P_{lt} means long-term flicker indicator
T_{dt}	0.2	T_{dt} means maximum time that dt exceeds 3%
$d_{max}(\%)$	4%	d_{max} means maximum relative voltage change.
$d_c(\%)$	3.3%	d_c means relative steady-state voltage change.

7.5. Configuration of EUT on Test

The following equipment are installed on Harmonic Current Test to meet the EN61000-3-3 requirements and operating regulations in a manner that tends to maximize its emission characteristics in normal application.

7.6. Operating Condition of EUT

- (1) Setup the EUT as shown as Section 7.2.
- (2) Turn on the power of all equipment.
- (3) Let the EUT work in test mode and 15 minutes before taking the test.

7.7. Test Procedure

- (1) The EUT was placed on the top of a wooden table 0.8 meters above the ground and operated to produce the most unfavorable sequence of voltage changes under normal conditions During the flick measurement; the measure time shall include that part of whole operation changes. The observation period for short-term flicker indicator is 10 minutes and the observation period for long-term flicker indicator is 2 hours.
- (2) The test results are reported on Section 7.8.

7.8. Voltage Fluctuation and Flicker Test Results

EUT : Warning Torch	Test Date : N/A
M/N : MO9326	Temperature : N/A
Test Engineer : N/A	Humidity : N/A
Test Voltage : N/A	Pressure : N/A
Test Mode : N/A	
Test Results : N/A	
Note: The EUT is supplied by battery, so this item does not applicable	

8. IMMUNITY PERFORMANCE CRITERIA

Performance Level

The test results shall be classified in terms of the loss of function or degradation of performance of the equipment under test, relative to a performance level by its manufacturer or the requestor of the test, or the agreed between the manufacturer and the purchaser of the product.

Definition related to the performance level:

1. Based on the used product standard
2. Based on the declaration of the manufacturer, requestor or purchaser

Criterion A:

Definition: normal performance within limits specified by the manufacturer, requestor and purchaser.

During the test no change of the luminous intensity shall be observed and the regulating control, if any shall operate during the test as intended.

Criterion B:

Definition: temporary loss of function or degradation of performance which ceases after the disturbance ceases, and from which the equipment under test recovers its normal performance, without operator intervention.

During the test the luminous intensity may change to any value. After the test the luminous intensity shall be restored to its initial value within 1 min. Regulating controls need not function during the test, but after the test the mode of the control shall be the same as before the test provided that during the test no mode changing commands were given.

Criterion C:

Definition: temporary loss of function or degradation of performance, the correction of which requires operator intervention.

During and after the test any change of the luminous intensity is allowed and the lamps may be extinguished. After the test, within 30 min, all functions shall return to normal if necessary by temporary interruption of the mains supply and/or operating the regulating control. Additional requirement for lighting equipment incorporating a starting device: after the test the lighting equipment is switched off. After half an hour it is switched on again. The lighting equipment shall start and operate as intended.

Criterion D:

Definition: loss of function or degradation of performance, which is not recoverable, owing to damage to hardware or software, or loss of data.

9. ELECTROSTATIC DISCHARGE TEST

9.1. Test Equipment

Item	Equipment	Manufacturer	Model No.	Serial No.	Last Cal.	Cal. Interval
1	ESD Tester	HAEFELY	PESD161 0	H310546	2016.09.30	1 Year

9.2. Block Diagram of Test Setup

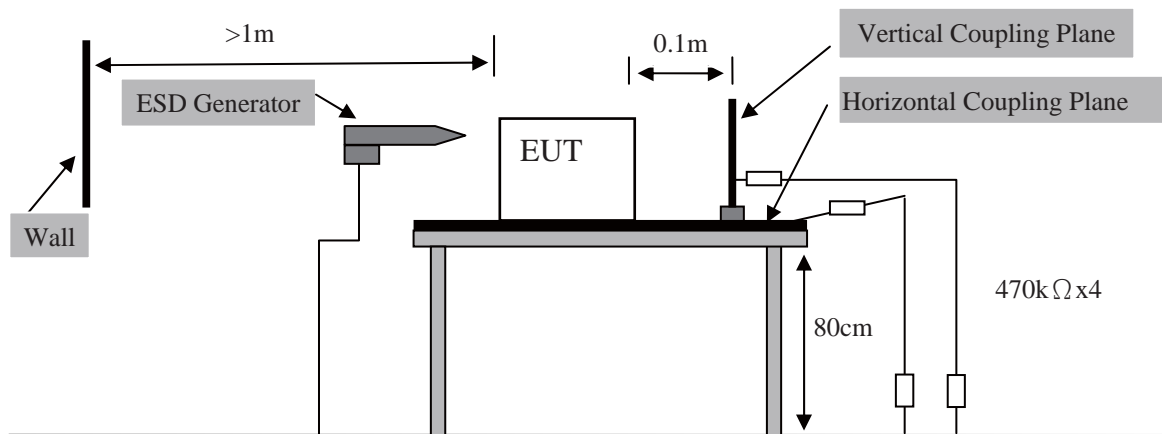

9.3. Test Standard

EN 61547:2009 (IEC 61000-4-2:2008)

9.4. Electrostatic Discharge Test Limits

Test Type	Test Level	Performance Criterion
Air Discharge	8KV	B
Contact Discharge	4KV	B

- Notes:
1. A performance criterion C could be applied to toys not using score or data entered by the user. Examples are musical soft toys, sounding toys, etc.
 2. Test set-up reference IEC 61000-4-2:2008

9.5. Configuration of EUT on Test

The following equipment are installed on Electrostatic Discharge Test to meet the IEC 61000-4-2 requirements and operating regulations in a manner that tends to maximize its emission characteristics in normal application.

9.6. Operating Condition of EUT

- (1) Setup the EUT as shown as Section 9.2.
- (2) Turn on the power of all equipment.
- (3) Let the EUT work in test mode and 15 minutes before taking the test.

9.7. Test Procedure

- (1) Air Discharge:

The test was applied on non-conductive surfaces of EUT. The round discharge tip of the discharge electrode was approached as fast as possible to touch the EUT. After each discharge, the discharge electrode was removed from the EUT. The generator was re-triggered for a new single discharge and repeated 20 times for each pre-selected test point. This procedure was repeated until all the air discharge completed

- (2) Contact Discharge:

All the procedure was same as Section 9.7.1. except that the generator was re-triggered for a new single discharge for each pre-selected test point. The tip of the discharge electrode was touching the EUT before the discharge switch was operated.

- (3) Indirect discharge for horizontal coupling plane:

At least 20 single discharges were applied to the horizontal coupling plane, at points on each side of the EUT. The discharge electrode positions vertically at a distance of 0.1m from the EUT and with the discharge electrode touching the coupling plane.

- (4) Indirect discharge for vertical coupling plane:

At least 20 single discharge were applied to the center of one vertical edge of the coupling plane. The coupling plane, of dimensions 0.5m X 0.5m, was placed parallel to, and positioned at a distance of 0.1m from the EUT. Discharges were applied to the coupling plane, with this plane in sufficient different positions that the four faces of the EUT are completely illuminated.

9.8. Electrostatic Discharge Test Results

EUT	: Warning Torch	Test Date	: 2017. 08. 24	
M/N	: MO9326	Temperature	: 23.6°C	
Test Engineer	: Star Yang	Humidity	: 56%	
Test Voltage	DC 4.5V from battery	Pressure	101.3Kpa	
Test Mode	: ON			
Test Results	: PASS			
Discharge Voltage (kV)	Type Of Discharge	Dischargeable Points	Performance	
			Required	Observation
±4	Contact	N/A	B	N/A
±8	Air	1	B	A
±4	HCP-Bottom	Edge of the HCP	B	A
±4	VCP-Front	Center of the VCP	B	A
±4	VCP-Left	Center of the VCP	B	A
±4	VCP-Back	Center of the VCP	B	A
±4	VCP-Right	Center of the VCP	B	A
Discharge Points Description				
<u>1</u>	Slots	<u>4</u>		
<u>2</u>		<u>5</u>		
<u>3</u>		<u>6</u>		
Note:	1. For the time interval between successive single discharges an initial value of one second. 2. EUT does not contain metal contact points, not need to contact discharge measurement 3. Class A is no function loss.			

10. RF FIELD STRENGTH SUSCEPTIBILITY TEST

10.1. Test Equipment

Item	Equipment	Manufacturer	Model No.	Serial No.	Last Cal	Cal. Interval
1.	vector Signal Generator	Agilent	E4438C	US44271917	2016.09.29	1 Year
2.	Power meter	Agilent	E4419B	GB40202122	2016.09.29	1 Year
3.	Power Sensor	Agilent	E9300A	MY41496625	2016.09.29	1 Year
4.	RF power Amplifier	OPHIR	5225R	1045	N/A	NCR
5.	RF power Amplifier	OPHIR	5273R	1018	N/A	NCR
6.	Antenna	SCHWARZBECK	STLP9128E-special	STLP9128E s#139	N/A	NCR
7.	Antenna	SCHWARZBECK	STLP9128E-special	STLP 9149 #456	N/A	NCR

10.2. Block Diagram of Test Setup

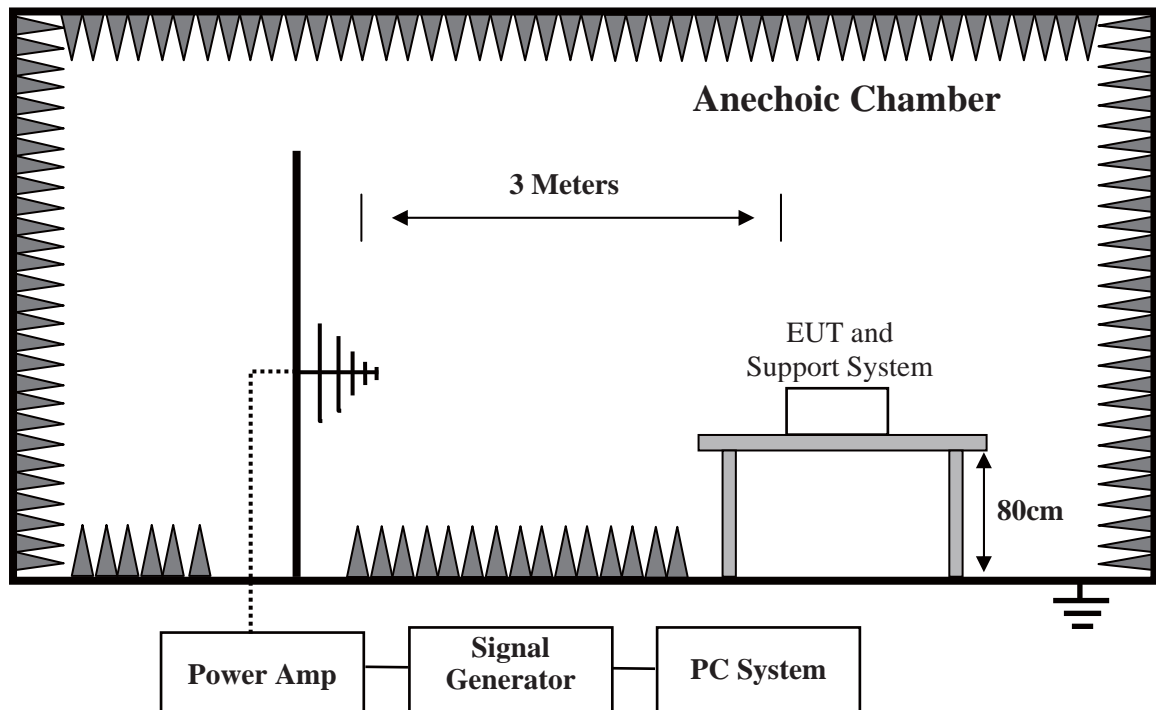

10.3. Test Standard

EN 61547: 2009 (IEC 61000-4-3:2006+A1:2007+A2:2010)

10.4.RF Field Strength susceptibility Test Limits

Test Specifications	Test Level	Performance Criterion
80MHz-1000MHz	3V/m (r.m.s.)	A

Notes: 1. Test set-up reference IEC 61000-4-3:2006 + A1:2007 + A2:2010

10.5.Configuration of EUT on Test

The following equipment are installed on Electrostatic Discharge Test to meet the IEC 61000-4-3 requirements and operating regulations in a manner that tends to maximize its emission characteristics in normal application.

10.6.Operating Condition of EUT

- (1) Setup the EUT as shown as Section 10.2.
- (2) Turn on the power of all equipment.
- (3) Let the EUT work in test mode and 15 minutes before taking the test.

10.7.Test Procedure

- (1) Testing was performed in a Fully anechoic chamber as recommended by IEC 61000-4-3. The EUT was placed on an 80 cm high non-conductive table located in the area of field uniformity. The radiating antenna was placed 3m in front of the EUT and Support system, and dwell time of the radiated interference was controlled by an automated, computer-controlled system.
- (2) The signal source was stepped through the applicable frequency range at a rate no faster than 1% of the fundamental. The signal was amplitude modulated 80% over the frequency range 80 MHz to 1GHz at a level of 3 V/m. The dwell time was set at 3 s. Field presence was monitored during testing via a field probe placed in close proximity to the EUT.
- (3) Throughout testing, the EUT was closely monitored for signs of susceptibility. The test was performed with the antennae oriented in both a horizontal and vertical polarization.
- (4) All the scanning conditions are as follows:

Condition of Test	Require of Test
Test Fielded Strength	3 V/m
Radiated Signal	80% amplitude modulated with a 1kHz sine wave
Scanning Frequency	80 - 1000 MHz
Sweeping time of radiated	0.0015 decade/s
Dwell Time	1 Sec.

10.8.RF Field Strength Susceptibility Test Results

EUT	: Warning Torch	Test Date	: 2017. 08. 24		
M/N	: MO9326	Temperature	: 23.6°C		
Test Engineer	: Star Yang	Humidity	: 56%		
Test Voltage	DC 4.5V from battery	Pressure	101.3Kpa		
Test Mode	: ON				
Test Results	: PASS				
Modulation:	<input checked="" type="checkbox"/> AM	<input type="checkbox"/> Pulse	<input type="checkbox"/> none 1 kHz 80%		
	Frequency Range :80 MHz -1000MHz				
Steps	1%				
	Horizontal		Vertical	Result	
	Required	Observation	Required	Observation	(Pass / Fail)
Front	A	A	A	A	Pass
Right	A	A	A	A	Pass
Rear	A	A	A	A	Pass
Left	A	A	A	A	Pass
Note:	1. Class A is no function loss.				

11. ELECTRICAL FAST TRANSIENT/BURST IMMUNITY TEST

11.1. Test Equipment

Item	Equipment	Manufacturer	Model No.	Serial No.	Last Cal	Cal. Interval
1.	Multifunctional Compact Immunity Test system	3ctest	CCS 600	ES0801655	2016.10.14	1 Year
2.	Surge & EFT Coupling Decoupling Network	3ctest	SEPN 3832T	ES0951601	2016.10.14	1 Year
3.	Voltage variation and PF magnetic field regulating device	3ctest	VMT2216S	ES0441601	2016.10.14	1 Year
4.	Capacitive Coupling Clamp	3ctest	CCC 100	EC0441660	2016.10.14	1 Year

11.2. Block Diagram of Test Setup

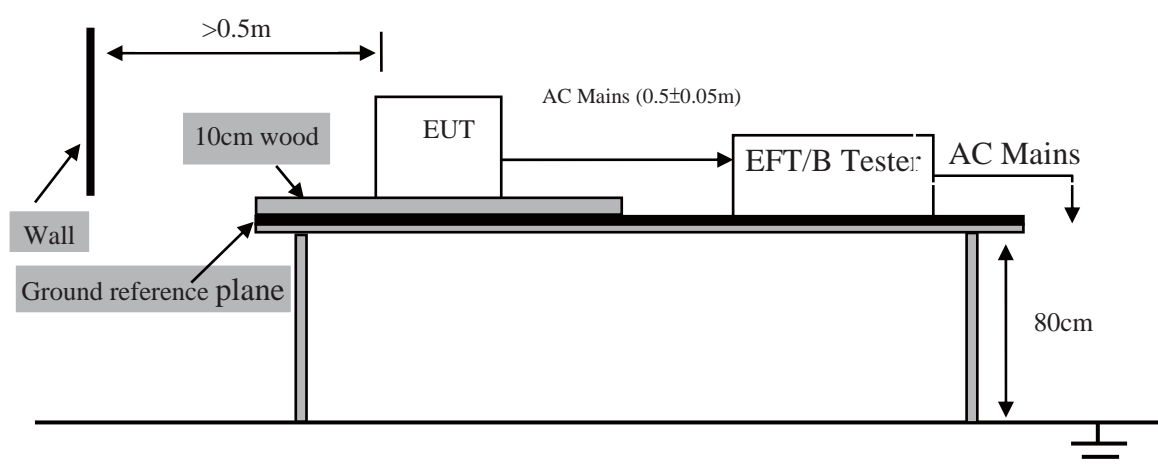

11.3. Test Standard

EN 61547:2009(IEC 61000-4-4: 2012)
(Severity Level 2 at 1kV)

11.4. Electrical Fast Transient/Burst Test Limits

Level	On Power Supply Lines	On I/O (Input/Output) Signal data and control lines
1.	0.5 kV	0.25 kV
2.	1 kV	0.5 kV
3.	2 kV	1 kV
4.	4 kV	2 kV
X	Special	Special

- Notes:
1. Test set-up reference IEC 61000-4-4:2012
 2. Performance criterion : **B**

11.5. Configuration of EUT on Test

The following equipment are installed on Electrostatic Discharge Test to meet the IEC 61000-4-4 requirements and operating regulations in a manner that tends to maximize its emission characteristics in normal application.

11.6. Operating Condition of EUT

- (1) Setup the EUT as shown as Section 11.2.
- (2) Turn on the power of all equipment.
- (3) Let the EUT work in test mode and 15 minutes before taking the test.

11.7. Test Procedure

The EUT and its simulators were placed on the ground reference plane and were insulated from it by a wood support 0.1m + 0.01m thick. The ground reference plane was 1m*1m metallic sheet with 0.65mm minimum thickness. This reference ground plane was project

- (1) beyond the EUT by at least 0.1m on all sides and the minimum distance between EUT and all other conductive structure, except the ground plane was more than 0.5m. All cables to the EUT was placed on the wood support, cables not subject to EFT/B was routed as far as possible from the cable under test to minimize the coupling between the cables.

11.7.1. For input and AC power ports:

The EUT was connected to the power mains by using a coupling device that couples the EFT interference signal to AC power lines. Both positive transients and negative transients of test voltage were applied during compliance test and the duration of the test can't less than 1min.

11.7.2. For signal lines and control lines ports:

No I/O ports. It's unnecessary to test.

11.7.3. For DC input and DC output power ports:

It's unnecessary to test.

11.8. Electrical Fast Transient/Burst immunity Test Results

EUT : Warning Torch	Test Date : N/A
M/N : MO9326	Temperature : N/A
Test Engineer : N/A	Humidity : N/A
Test Voltage : N/A	Pressure : N/A
Test Mode : N/A	
Test Results : N/A	
Note: The EUT is supplied by battery, so this item does not applicable	

12.SURGE TEST

12.1.Test Equipments

Item	Equipment	Manufacturer	Model No.	Serial No.	Last Cal.	Cal. Interval
1.	Multifunctional Compact Immunity Test system	3ctest	CCS 600	ES0801655	2016.10.14	1 Year
2.	Surge & EFT Coupling Decoupling Network	3ctest	SEPN 3832T	ES0951601	2016.10.14	1 Year
3.	Voltage variation and PF magnetic field regulating device	3ctest	VMT22 16S	ES0441601	2016.10.14	1 Year
4.	Capacitive Coupling Clamp	3ctest	CCC 100	EC0441660	2016.10.14	1 Year

12.2.Block Diagram of Test Setup

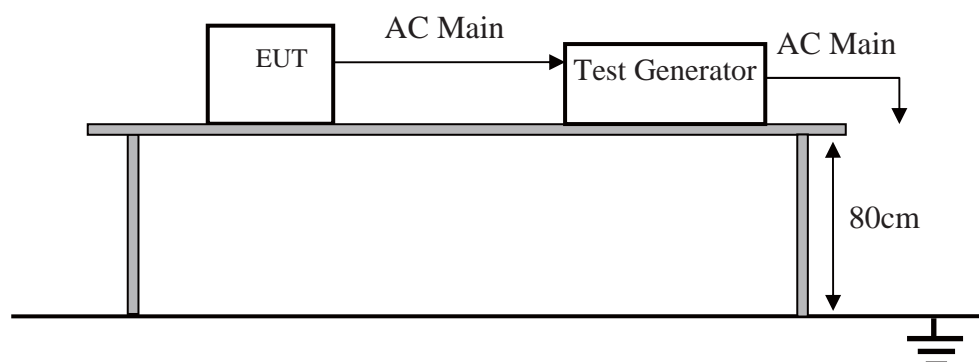

12.3.Surge Test Limits

Characteristics	Test levels			
	Self-ballasted lamps and semi-luminaires	Luminaires and independent auxiliaries		
		Input power		
		≤25 W	>25 W	
Wave-shape data	1,2/50 μs	1,2/50 μs	1,2/50 μs	
Test levels				
line to line	±0,5 kV	±0,5 kV	±1,0 kV	
line to ground	±1,0 kV	±1,0 kV	±2,0 kV	

NOTE In addition to the specified test level, all lower test levels as detailed in IEC 61000-4-5 should also be satisfied.

Severity level

Severity Level [↵]	Open-Circuit Test Voltage [↵] kV [↵]
1 [↵]	0.5 [↵]
2 [↵]	1.0 [↵]
3 [↵]	2.0 [↵]
4 [↵]	4.0 [↵]
* [↵]	Special [↵]

Performance criterion : B**12.4.Configuration of EUT on Test**

The following equipment are installed on Electrostatic Discharge Test to meet the IEC 61000-4-5 requirements and operating regulations in a manner that tends to maximize its emission characteristics in normal application.

12.5.Operating Condition of EUT

- (1) Setup the EUT as shown as Section 12.2.
- (2) Turn on the power of all equipment.
- (3) Let the EUT work in test mode and 15 minutes before taking the test.

12.6.Test Procedure

- (1) For line to line coupling mode, provide a 1.0kV 1.2/50us voltage surge (at open-circuit condition) and 8/20us current surge to EUT selected points.
- (2) At least 5 positive and 5 negative (polarity) tests with a maximum 1/min repetition rate are conducted during test.
- (3) Different phase angles are done individually.
- (4) Record the EUT operating situation during compliance test and decide the EUT immunity criterion for above each test.

12.7.Surge Test Results

EUT	: Warning Torch	Test Date	: N/A
M/N	: MO9326	Temperature	: N/A
Test Engineer	: N/A	Humidity	: N/A
Test Voltage	: N/A	Pressure	: N/A
Test Mode	: N/A		
Test Results	: N/A		
Note	: The EUT is supplied by battery, so this item does not applicable		

13. INJECTED CURRENTS SUSCEPTIBILITY TEST

13.1. Test Equipments

Item	Equipment	Manufacturer	Model No.	Serial No.	Last Cal.	Cal. Interval
1.	CONDUCTED IMMUNITY TEST SYSTEM (RF-Generator)	Frankonia	CIT-10/75	12681247/2013	2016.09.29	1 Year
2.	Fixed Coaxial Attenuator (6dB Attenuation)	CD	ATT-0675	120540086	2016.09.29	1 Year
3.	coupling-decoupling network (CDN)	CD	CDN M2/M3	2302	2016.09.29	1 Year
4.	Electromagnetic Injection Clamp (EMC-Clamp)	CD	EM-Clamp	0513A031201	2016.09.29	1 Year

13.2. Block Diagram of Test Setup

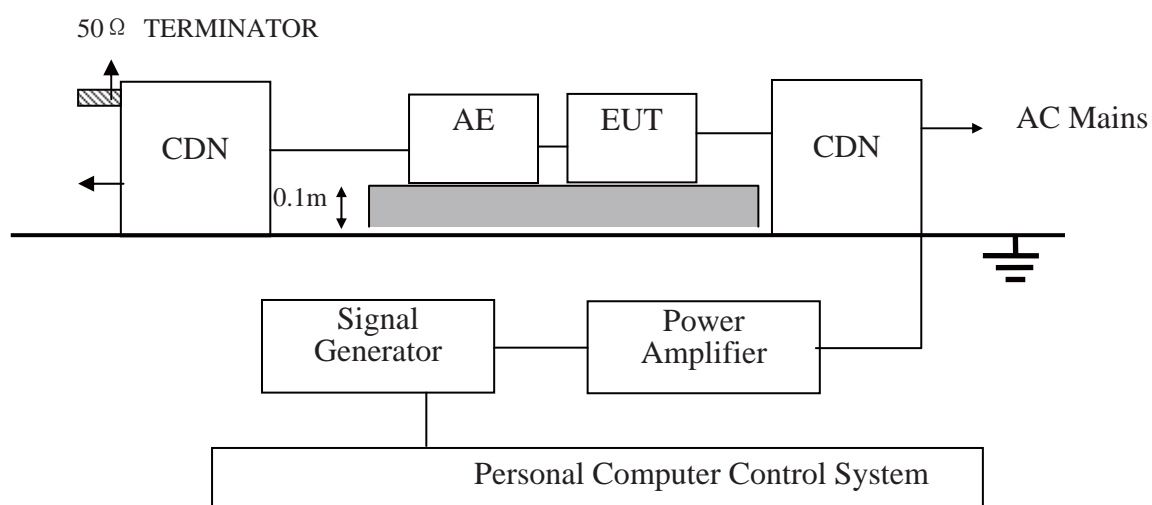

13.3. Test Standard

EN 61547: 2009 (IEC 61000-4-6: 2013)

(Severity Level 2 at 3Vrms and frequency is from 0.15MHz to 80MHz)

13.4. Injected currents susceptibility Test Limits

Level	Voltage Level (e.m.f.) V
1	1
2	3
3	10
X	Special

- Notes:
1. Test set-up reference IEC 61000-4-6:2013
 2. Performance criterion: **A**

13.5. Configuration of EUT on Test

The following equipment are installed on Electrostatic Discharge Test to meet the IEC 61000-4-6 requirements and operating regulations in a manner that tends to maximize its emission characteristics in normal application.

13.6. Operating Condition of EUT

- (1) Setup the EUT as shown as Section 13.2.
- (2) Turn on the power of all equipment.
- (3) Let the EUT work in test mode and 15 minutes before taking the test.

13.7. Test Procedure

- (1) Let the EUT work in test mode and test it.
The EUT are placed on an insulating support 0.1m high above a ground reference plane.
- (2) CDN (coupling and decoupling device) is placed on the ground plane about 0.3m from EUT. Cables between CDN and EUT are as short as possible, and their height above the ground reference plane shall be between 30 and 50 mm (where possible).
- (3) The disturbance signal described below is injected to EUT through CDN.
- (4) The EUT operates within its operational mode(s) under intended climatic conditions after power on.
- (5) The frequency range is swept from 0.150MHz to 80MHz using 4.5V signal level, and with the disturbance signal 80% amplitude modulated with a 1kHz sine wave.
The rate of sweep shall not exceed 1.5×10^{-3} decades/s. Where the frequency is swept
- (6) incrementally, the step size shall not exceed 1% of the start and thereafter 1% of the preceding frequency value.
- (7) Recording the EUT operating situation during compliance testing and decide the EUT immunity criterion.

13.8. Injected currents susceptibility Test Results

EUT : Warning Torch	Test Date : N/A
M/N : MO9326	Temperature : N/A
Test Engineer : N/A	Humidity : N/A
Test Voltage : N/A	Pressure : N/A
Test Mode : N/A	
Test Results : N/A	
Note: The EUT is supplied by battery, so this item does not applicable	

14.MAGNETIC FIELD IMMUNITY TEST

14.1.Test Equipments

Item	Equipment	Manufacturer	Model No.	Serial No.	Last Cal	Cal. Interval
1.	Multifunctional Compact Immunity Test system	3ctest	CCS 600	ES0801655	2016.10.14	1 Year
2.	Surge & EFT Coupling Decoupling Network	3ctest	SEPN 3832T	ES0951601	2016.10.14	1 Year
3.	Voltage variation and PF magnetic field regulating device	3ctest	VMT2216S	ES0441601	2016.10.14	1 Year
4.	Capacitive Coupling Clamp	3ctest	CCC 100	EC0441660	2016.10.14	1 Year

14.2.Block Diagram of Test Setup

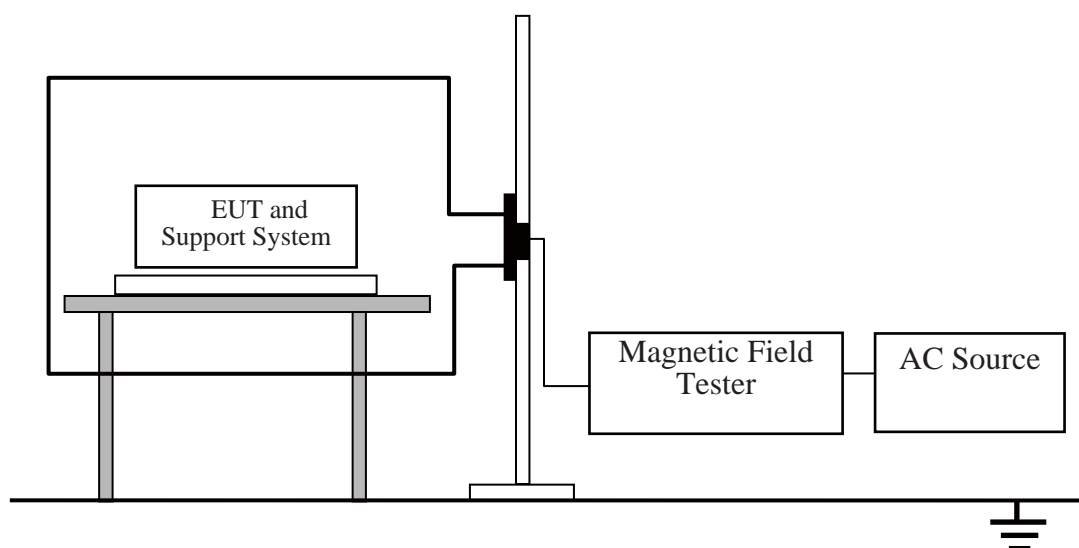

14.3.Test Standard

EN61547:2009(IEC 61000-4-8:2009)

14.4.magnetic field Test Limits

Level	Magnetic Field Strength A/m
1	1
2	3
3	10
4	30
5	100
X	Special

Notes: 1. Test set-up reference IEC 61000-4-8:2009

14.5.Configuration of EUT on Test

The following equipment are installed on Electrostatic Discharge Test to meet the IEC 61000-4-6 requirements and operating regulations in a manner that tends to maximize its emission characteristics in normal application.

14.6.Operating Condition of EUT

- (1) Setup the EUT as shown as Section 14.2.
- (2) Turn on the power of all equipment.
- (3) Let the EUT work in test mode and 15 minutes before taking the test.

14.7.Test Procedure

- The EUT was subjected to the test magnetic field by using the induction coil of standard dimensions (1m*1m) and shown in Section 14.2. The induction coil was then rotated by 90° in order to expose the EUT to the test field with different orientations.
- (1)

14.8.magnetic field immunity Test Results

EUT : Warning Torch	Test Date : N/A
M/N : MO9326	Temperature : N/A
Test Engineer : N/A	Humidity : N/A
Test Voltage : N/A	Pressure : N/A
Test Mode : N/A	
Test Results : N/A	
The EUT not containing devices susceptible to magnetic fields, and Power-frequency Note: magnetic field test applicable only to EUT containing devices susceptible to magnetic fields, so the test not applicable.	

15. VOLTAGE DIPS AND INTERRUPTIONS TEST

15.1. Test Equipments

Item	Equipment	Manufacturer	Model No.	Serial No.	Last Cal	Cal. Interval
1.	Multifunctional Compact Immunity Test system	3ctest	CCS 600	ES0801655	2016.10.14	1 Year
2.	Surge & EFT Coupling Decoupling Network	3ctest	SEPN 3832T	ES0951601	2016.10.14	1 Year
3.	Voltage variation and PF magnetic field regulating device	3ctest	VMT2216S	ES0441601	2016.10.14	1 Year
4.	Capacitive Coupling Clamp	3ctest	CCC 100	EC0441660	2016.10.14	1 Year

15.2. Block Diagram of Test Setup

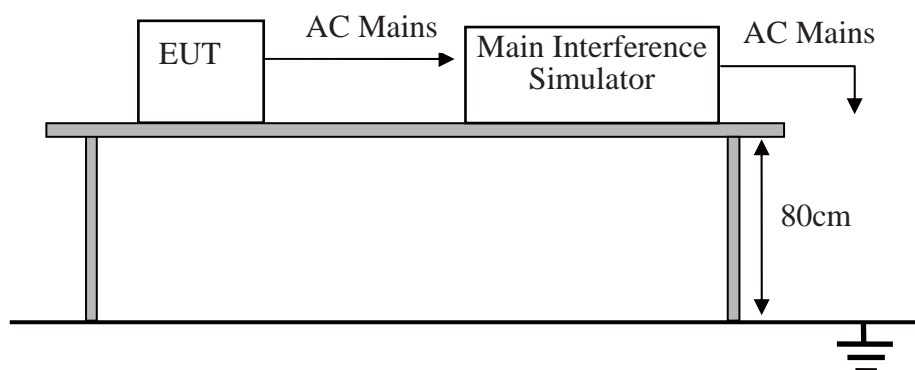

15.3. Test Standard

EN 61547: 2009 (IEC 61000-4-11: 2004)

15.4. Voltage dips and interruptions Test Limits

Test Level %U _T	Voltage dip and short interruptions %U _T	Performance Criterion	Duration (in period)
0	100	C	0.5
70	30	B	10

- Notes:
1. Test set-up reference IEC 61000-4-11:2004
 2. Performance criterion: **B&C**

15.5. Configuration of EUT on Test

The following equipment are installed on Electrostatic Discharge Test to meet the IEC 61000-4-11 requirements and operating regulations in a manner that tends to maximize its emission characteristics in normal application.

15.6. Operating Condition of EUT

- (1) Setup the EUT as shown as Section 15.2.
- (2) Turn on the power of all equipment.
- (3) Let the EUT work in test mode and 15 minutes before taking the test.

15.7. Test Procedure

- (1) The interruption is introduced at selected phase angles with specified duration.
- (2) Record any degradation of performance.

15.8.Voltage dips and interruptions Test Results

EUT	: Warning Torch	Test Date	: N/A
M/N	: MO9326	Temperature	: N/A
Test Engineer	: N/A	Humidity	: N/A
Test Voltage	: N/A	Pressure	: N/A
Test Mode	: N/A		
Test Results	: N/A		
Note	: The EUT is supplied by battery, so this item does not applicable		

16.PHOTOGRAPH

16.1.Photos of Radiated Disturbance Test (In Semi Anechoic Chamber)



16.2.Photos of Radiated Electromagnetic Disturbance Test



16.3.Photos of Electrostatic Discharge Test

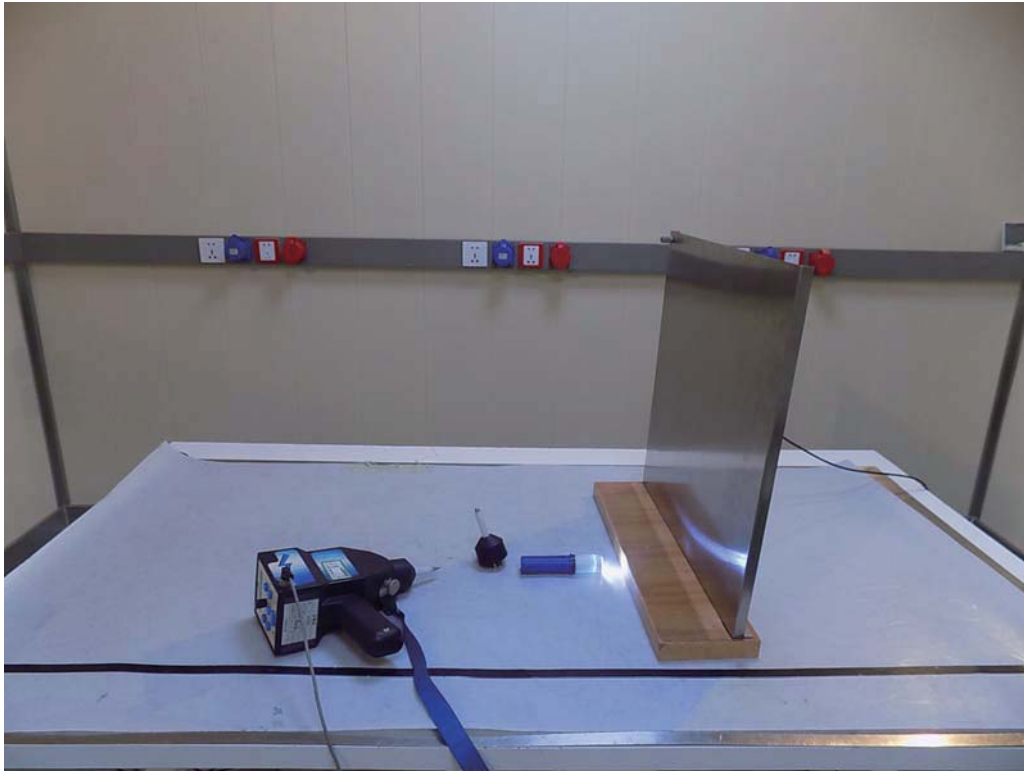

16.4.Photos of RF Field Strength Susceptibility Test

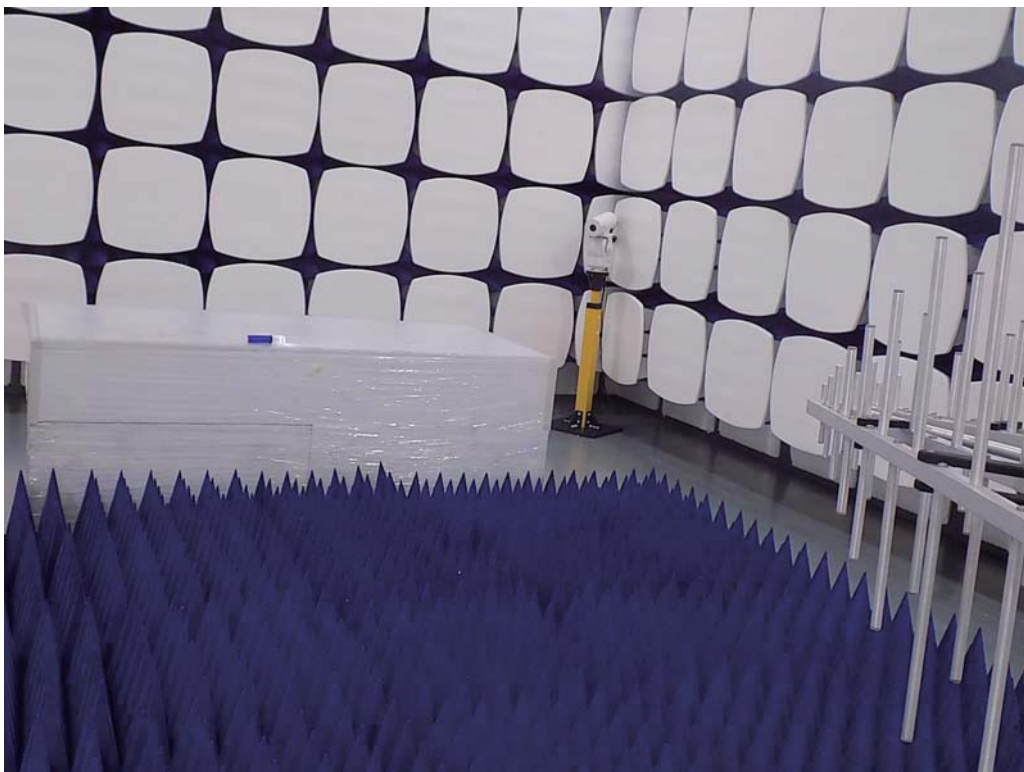

17.PHOTOS OF THE EUT



EUT View



EUT View

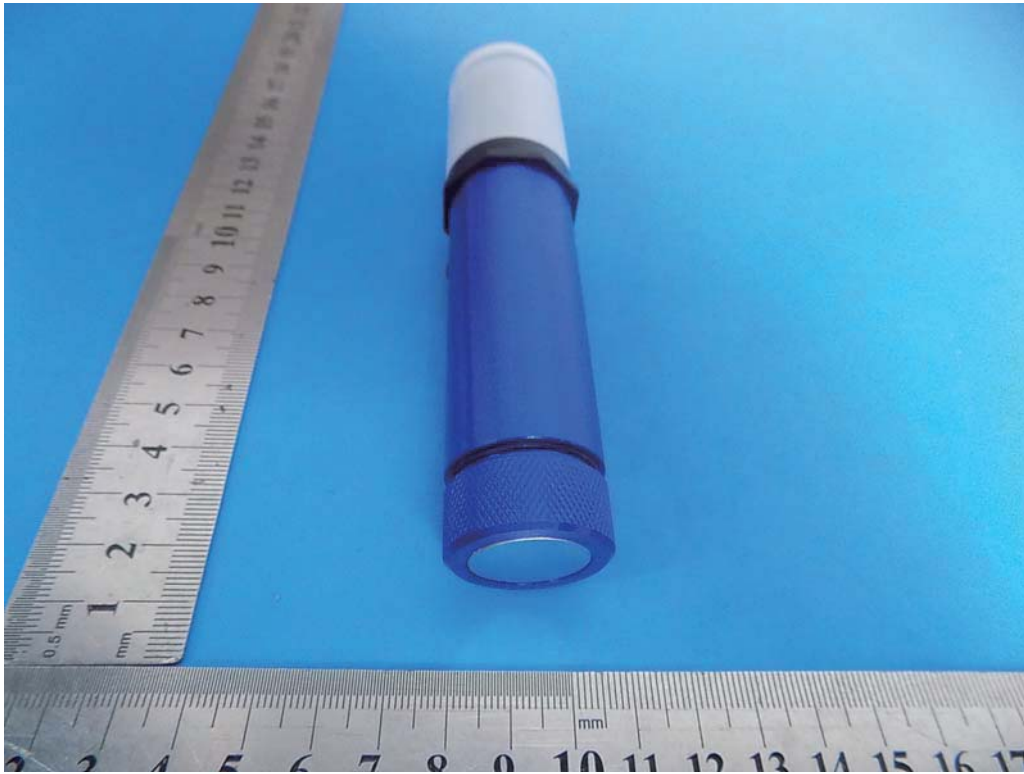

EUT View

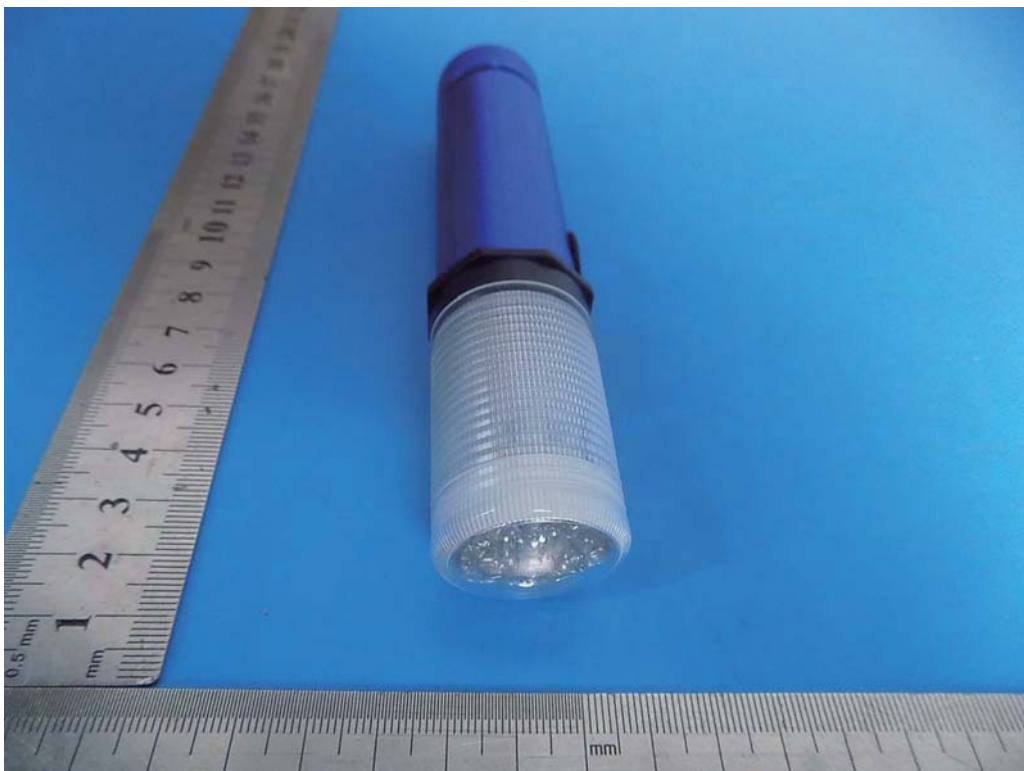

EUT View



EUT View



EUT View

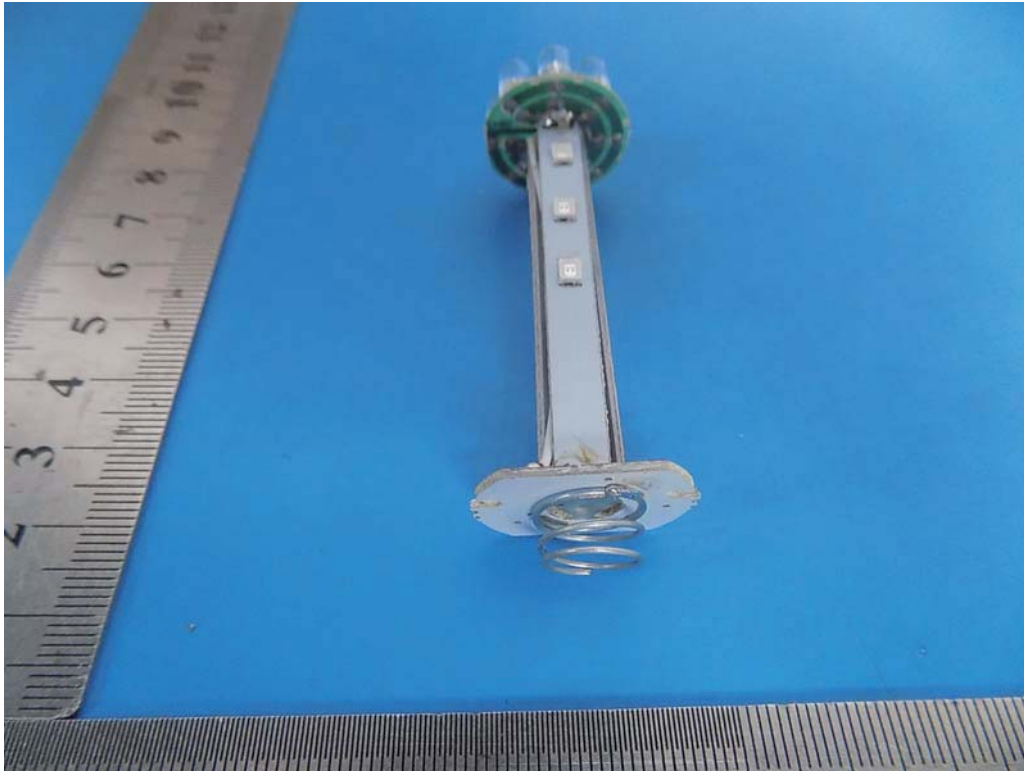

EUT View

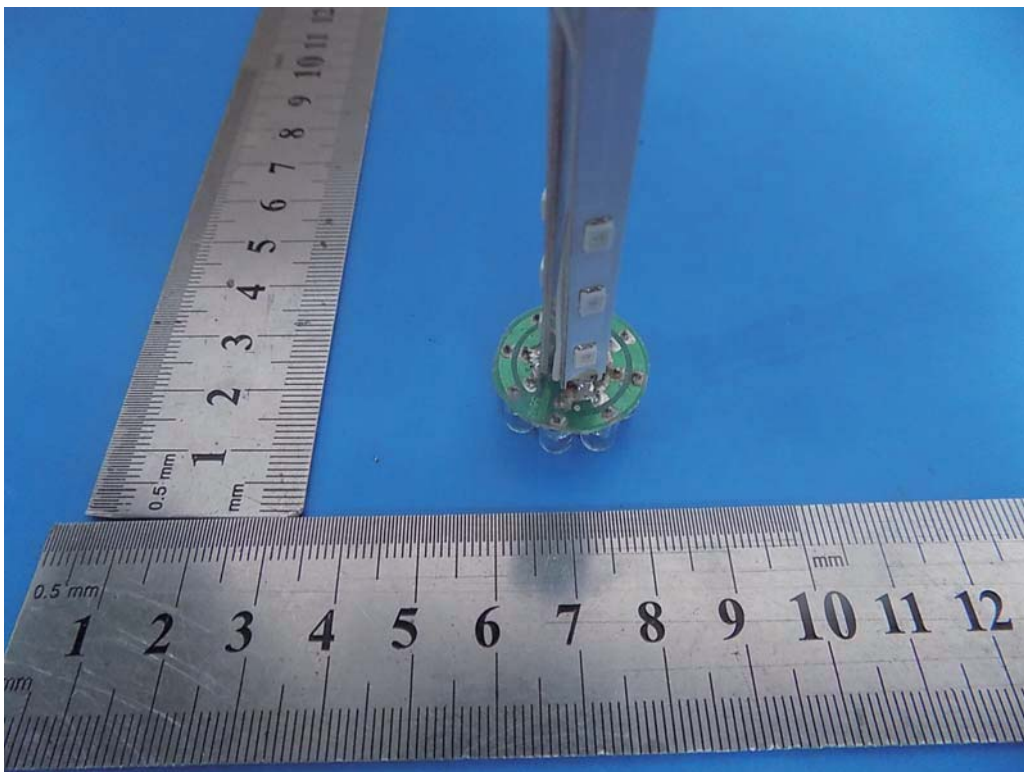

EUT View

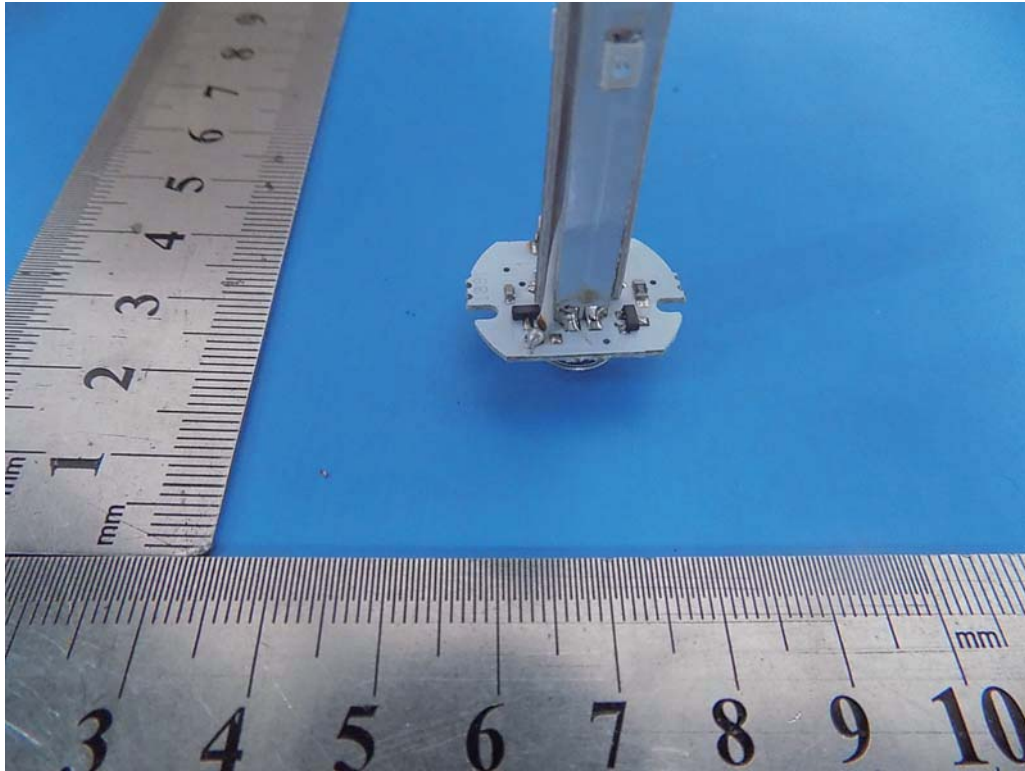

EUT View

----END OF REPORT----